



euro
appliances

dishwashers

USAGE AND
CARE GUIDE

PRODUCT
CODE:
EDD60S



QUICK USER GUIDE

Starting A Wash



1 Discard scraps

Scrape large food particles off and remove any foreign objects.

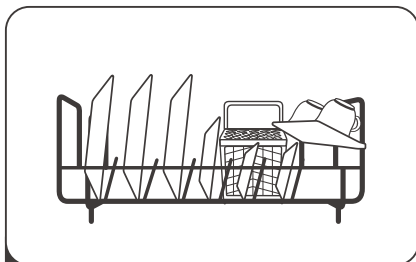

2 Load dishes carefully

For better washing result, place the dishes properly avoiding any contact or overlapping between them.

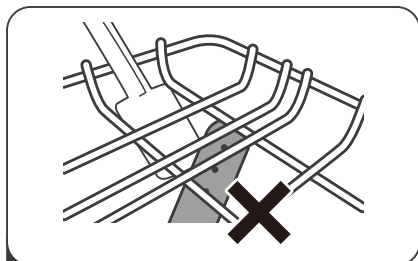

3 Check spray arm

Ensure there are no items blocking the spray arm from rotating.

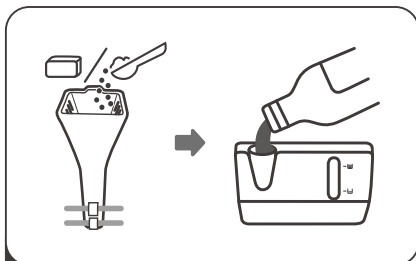

4 Add detergent and check rinse aid

If the "☼" indicator is lit, or the rinse aid is below the minimum capacity line, please refill.

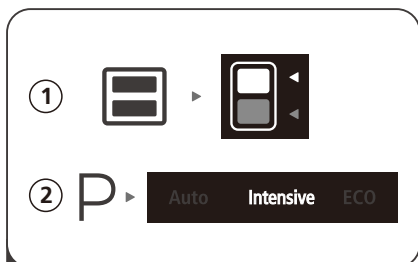

5 Set up the dishwasher function

Power the dishwasher on, then select drawer, wash program and function.

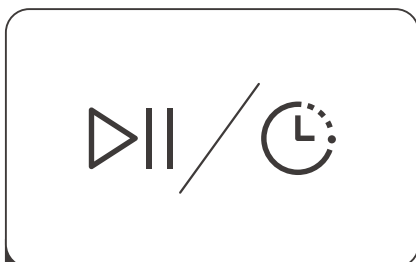

6 Start wash or set Delay time

Close the drawer and press "▶||".

After The Wash

The drying fan may continue to run for a set time after that the washing cycle is over or until the drawer is open.

For best drying result, we recommend to unloading the dishes when they have cooled down.

NOTE:

- Reviewing the section on **TROUBLESHOOTING TIPS** will help you solve some common problems by yourself.
- If you cannot solve the problems by yourself, please ask for help from a professional technician.
- The manufacturer, following a policy of constant development and updating of the product, may make modifications without giving prior notice.
- If lost or out-of-date, you can receive a new user manual from the manufacturer or responsible vendor.

CONTENTS

01	5	SAFETY INFORMATION
02	9	PRODUCT DESCRIPTION
	9	Product Overview
	10	Control Panel
03	13	USING YOUR DISHWASHER
	13	Basket Use Tips
	16	Preparing And Loading Dishes
	19	Adding Detergent
	19	Adding Rinse Aid
04	21	OPERATING THE APPLIANCE
	21	Wash Cycle Table
	22	Select A Drawer
	22	Starting A Cycle Wash
	23	Changing The Program Once Started
	23	Adding Items While A Wash Is In Progress
05	24	MAINTENANCE AND CLEANING
	24	External Care
	24	Internal Care
	27	Caring For The Dishwasher
06	28	INSTALLATION INSTRUCTION
	28	Product Dimensions
	29	Before Installation
	30	Installing Your Dishwasher
	34	Electrical Requirements
	34	Cold Water Connection
	35	Connection Of The Drain Hose
07	37	TROUBLESHOOTING TIPS
	39	Error Codes
	40	Product Specification

SAFETY INSTRUCTIONS

⚠ WARNING

READ ALL INSTRUCTIONS BEFORE USE

It is your responsibility to use caution when installing, maintaining, and operating your dishwasher.

We will not be liable for any damage resulting from improper use.

This is the safety alert symbol. This symbol alerts you to potential hazards that can result in property damage or serious bodily harm, even death.

The safety alert symbol will be followed by either the word “WARNING” or “CAUTION” then an important safety message. These words mean:

⚠ WARNING

Indicates the possibility of serious bodily harm or death.

⚠ CAUTION

Indicates the possibility of injury or damage to property.

Basic Safety Precautions

- This appliance is intended to be used in household and similar applications such as:
 - staff kitchen areas in shops, offices and other working environments;
 - farm houses;

- by clients in hotels, motels and other residential type environments;
- bed and breakfast type environments.
- This appliance can be used by children aged from 8 years and above and persons with reduced physical, sensory or mental capabilities or lack of experience and knowledge providing they have been given supervision or instruction concerning use of the appliance in a safe way and understand the hazards involved.
- Children should not play with the appliance. Cleaning and user maintenance should not be done by children without supervision.(For EN60335-1)
- This appliance is not intended for use by persons (including children) with reduced physical, sensory or mental capabilities, or lack of experience and knowledge, unless they have been given supervision or instruction regarding the use of the appliance by a person responsible for their safety. (For IEC60335-1)
- Packaging material could be dangerous for children!
- This appliance is for indoor household use only.
- To protect against the risk of electrical shock, do not immerse the unit, cord or plug in water or other liquid.
- Unplug before cleaning and performing maintenance on the appliance.
- Do not put downward force on either opened drawer prior to the dishwasher being fully installed. It will be unstable and may tip forward.

- Do not use the dishwasher before it is fully installed as per the Installation Instructions. It will be unstable and be likely to tip forward.
- Do not operate the dishwasher without all the enclosures fixed in place.
- The sharp edges of knives and utensils with sharp points should not face upwards.
- Some dishwasher detergents are strongly alkaline. They can be extremely dangerous if swallowed. Avoid contact with the skin and eyes and keep children away from the dishwasher when the door is open.

Check that the detergent receptacle is empty after completion of the wash cycle.

The door should not be left open position since this could present a tripping hazard.

- When emptying the dishwasher, check that all the detergent has been dissolved.
- The inlet water hose supplied must be used. Do not reuse a used or old hose.
- The power cable must be safely routed. If it is ever damaged, it must be replaced with a similar item by a registered electrician.
- An earthed 3 pin socket must be used. Consult a registered electrician if there is doubt regarding the earth connection.

Product Disposal

- The packaging can be recycled.
- If the product is to be disposed of, do this responsibly at your local Council Waste Depot.



- **DISPOSAL: Do not dispose this product [REDACTED] as unsorted municipal waste. Collection of such waste separately for special treatment is necessary.**

PRODUCT DESCRIPTION

❗ IMPORTANT:

To get the best performance from your dishwasher, read all operating instructions before using it for the first time.

Product Overview

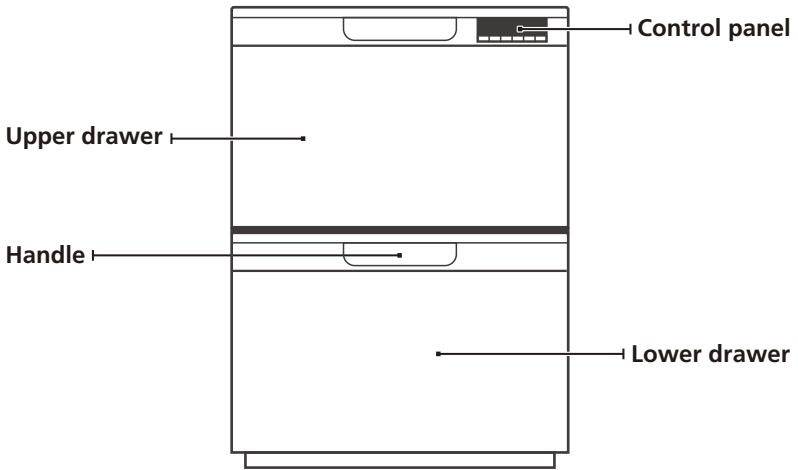

Cutlery basket



Detergent chute

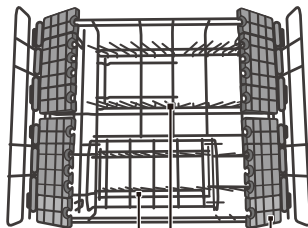

Adjustable racks Cup rack

Basket

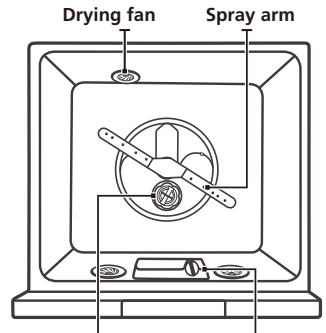

Drying fan Spray arm
Filter assembly Dispenser

Tub

Control Panel

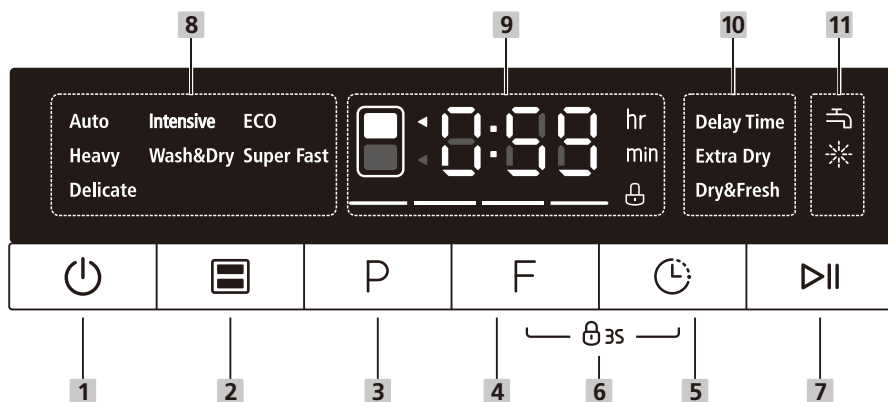

Operation (Button)





1 Power	Press this button to turn on your dishwasher, the screen will light up.
2 Drawer selector	Press the button to select either upper drawer or lower drawer loaded, the corresponding indicator will light up.
3 Program selector	Press this button to select the appropriate washing program, the selected program indicator will light up.
4 Option selector	Press the button to select a option, corresponding indicator will be lit. Press and hold the Option button for 3 seconds in standby mode to run the Dry & Fresh option immediately.
5 Delay time	Press the button to increase the delay start time. Delay a cycle for up to 24 hours in one-hour increments. After setting the delay time, press the Start/Pause button to start.
6 Child lock	This option allows you to lock the buttons on the control panel, so children cannot accidentally start the dishwasher by pressing the buttons on the panel. Only the Power button and Drawer selector button remains active. To lock or unlock the buttons on the control panel, press and hold the Option button+ Delay button for 3 seconds simultaneously.

<p>7 Start/Pause</p>	<p>To start the selected washing program or pause it when the dishwasher is operating.</p> <p>When the dishwasher is running, if you need to open the drawer, please press the “Start/Pause” button first and wait a few seconds, then open the door slowly.</p>
-----------------------------	--





Display

<p>8 Washing program</p>	<p>Auto Auto sensing wash, lightly, or heavily soiled crockery, with or without dried-on food.</p> <p>Intensive For heaviest soiled crockery, such as pots, pans, casserole dishes and dishes that have been sitting with dried food on them for some time.</p> <p>ECO For normally soiled loads, such as pots, plates, glasses and lightly soiled pans, standard everyday cycle.</p> <p>Heavy For heavily soiled loads, such as pots, plates, glasses and lightly soiled pans.</p> <p>Wash&Dry For lightly soiled plates and pans that need a quick wash.</p> <p>Super Fast A shorter wash for lightly soiled loads that do not need drying.</p> <p>Delicate For fragile items such as fine china and glassware.</p>
<p>9 Screen</p>	<p>Show the operating drawer, time reminding, delay time, error code etc, Child lock indication.</p>

Display

<p>10 Option</p>	<p>Delay Time If the delay time is set, the corresponding indicator will be lit.</p> <p>Extra Dry For better drying result. (It can only be used with Intensive, ECO, Heavy, Wash&Dry, Delicate.)</p> <p>Dry&Fresh  Dry&Fresh For removing bad odor and moisture even when dishes are left longer time in the baskets. A) when selected this option will start to run at the end of the washing cycle, its indicator will blink. B) Press and hold the Option button for 3s, when dishwasher is on, for let the option run immediately.</p>
<p>11 Warning</p>	<p> Water Supply Failure If the "  " indicator is lit, it means that no water is reaching the dishwasher.</p> <p> Rinse Aid If the "  " indicator is lit, it means the dishwasher is low on dishwasher rinse aid and requires refilling.</p>

Washing progress

Main-wash	
Rinse	
Drying	
End	

USING YOUR DISHWASHER

Before using your dishwasher :

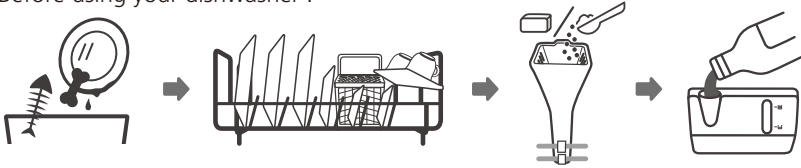

1. Removing the larger residue off the wash items
2. Loading the basket
3. Loading the detergent
4. Filling the rinse aid dispenser

Basket Use Tips

There are many ways to adjust the loading pattern of the basket.

Removing the rear rack

The rear rack can be removed to create a flat surface for such things as pots and pans.

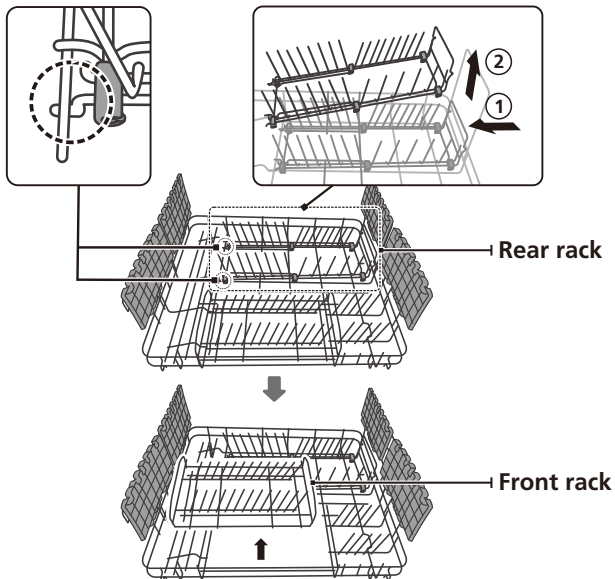

Folding down the pins

- The spacing between the pins can be increased by folding them down. This will help the loading of large bowls and deep pot and pans.
- The pins on the front rack can also be folded down to create a flat space.
- Do not load the basket with the front rack removed. It is removable only to allow access to the filters for servicing. The risk is too great because item could fall in the open space and damage the rotating spray arm.
- If returning the rear rack, be sure to firmly set it into it's correct place.

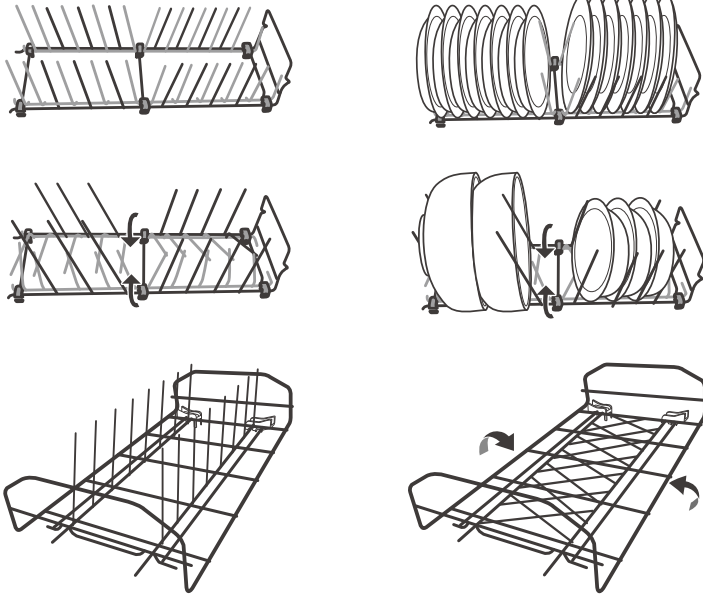

Using the cup racks

Cups and glasses and large utensils fit on the cup racks. The fronts of the racks are designed to secure wine glasses.

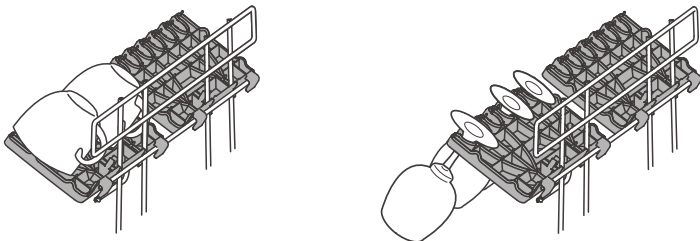

Adjustable the cup racks

You can adjust these cup racks to different heights independently:

1. Fold the cup racks if you need more space.
2. Remove the cup holder and install it on a iron wire of different height to adjust the height of the cup holder.

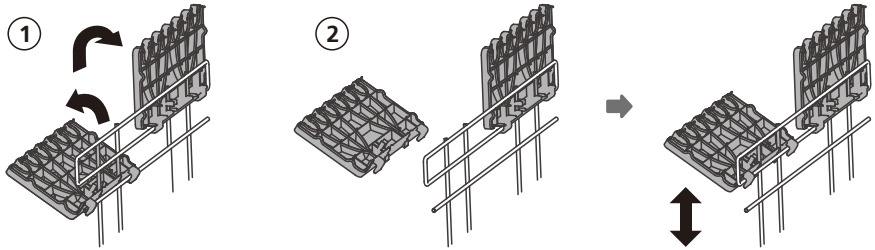

Two positions cutlery basket

The cutlery basket is made in two halves.

The cutlery basket is composed by two foldable half.

Is possible to used it open or fold as in the drawing.

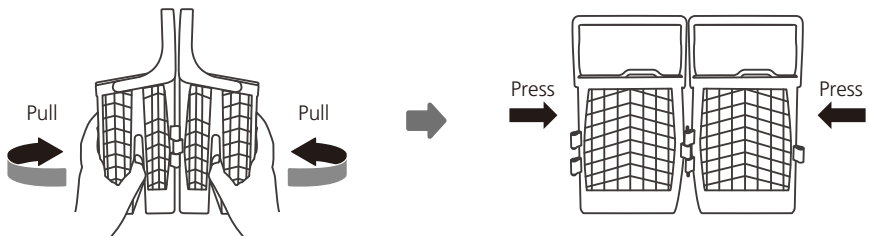

You can use the cutlery basket with the cover open.



Preparing And Loading Dishes

- Consider buying utensils which are identified as dishwasher-proof.
- For particular items, select a program with the lowest possible temperature.
- To prevent damage, do not take glass and cutlery out of the dishwasher immediately after the program has ended.

For washing the following cutlery/dishes

Are not suitable

- Cutlery with wooden, horn china or mother-of-pearl handles
- Plastic items that are not heat resistant
- Older cutlery with glued parts that are not temperature resistant
- Bonded cutlery items or dishes
- Pewter or copper items
- Crystal glass
- Steel items subject to rusting
- Wooden platters
- Items made from synthetic fibres

Are of limited suitability

- Some types of glasses can become dull after a large number of washes
- Silver and aluminum parts have a tendency to discolor during washing
- Glazed patterns may fade if machine washed frequently

Recommendations for loading the dishwasher

Scrape off any large amounts of leftover food. Soften remnants of burnt food in pans. It is not necessary to rinse the dishes under running water.

For best performance of the dishwasher, follow these loading guidelines.

Place objects in the dishwasher in following way:

- Items such as cups, glasses, pots/pans, etc. are faced downwards.
- Curved items, or ones with recesses, should be loaded on a slant so that water can run off.
- All utensils are stacked securely and can not tip over.
- Be sure that no wash items protrude through the basket base where they will likely foul the spray arm.
- Load hollow items such as cups, glasses, pans etc. With the opening facing downwards so that water cannot collect in the container or a deep base.
- Dishes and items of cutlery must not lie inside one another, or cover each other.

- To avoid damage, glasses should not touch one another.
- Please do not overload your dishwasher. This is important for good results and for reasonable consumption of energy.

NOTE:

Very small items should not be washed in the dishwasher as they could easily fall through the basket.

CAUTION



Items will be hot! To prevent damage, do not take glass and cutlery out of the dishwasher for around 15 minutes after the program has ended.

Loading the dishwasher

The loading pattern in the illustration is recommended for the design of basket. It is the pattern used for the Standards Wash Test (AS/NZS 2007.1).

NOTE:

Cups and glasses face downwards.

Plates face the back of each other, as do side plates, soup plates and saucers.

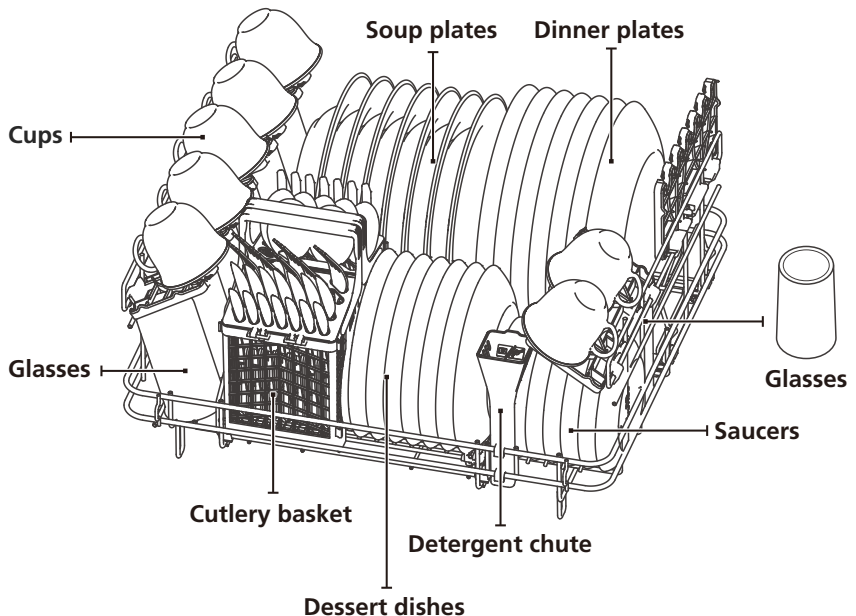

Loading the cutlery basket

You can place each knife, spoon, or fork separately into the spoon stands in the basket's covers to prevent chipping and discoloration.

The spoon stands as seen from above with the suggested placement of cutlery items. Match the numbers in the diagram to the numbers in the list of cutlery items above.

⚠ WARNING



Always load sharp utensils with the sharp point down!
Do not let any item extend through the bottom.

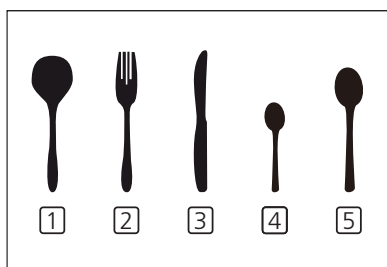
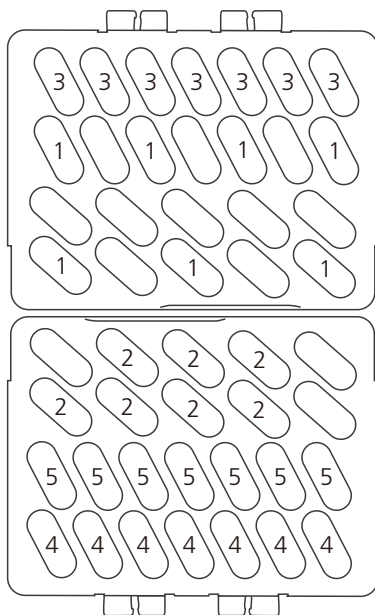

Number	Item
1	Soup spoons
2	Forks
3	Knives
4	Teaspoons
5	Dessert spoons

Settings for Standards Wash Test AS/NZS 2007.1

Capacity: 7 Place settings per drawer

Wash Program: ECO

Detergent quantity: 24g

Rinse Aid setting: D3

To shorten the drying time, the drawer can be opened approx. 50 mm at the end of the wash cycle.

This however is not compulsory.

The wash load will dry completely given the drying time suggested in the table on page 21.

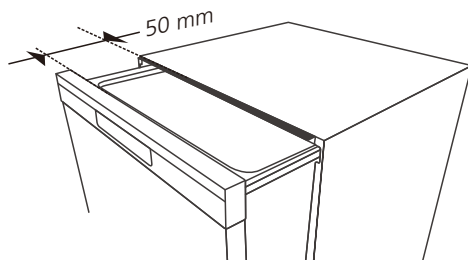

Adding Detergent

The chemicals in Dishwasher Detergent are necessary to remove, dissolve and help dispose of all the soils from the wash load.

Only specific Electric Dishwasher Detergent is capable of doing this.

⚠ WARNING

- **Dishwasher detergent is dangerous. Avoid skin and eye contact**
- **Keep the dishwasher detergent out of reach of children.**
- **Keep it sealed in a dry place.**

Add the recommended quantity of detergent to the detergent chute on the basket.



Adding Rinse Aid

Rinse Aid is added during the final rinse to assist the wash load drying and to prevent spots and streaks on glassware.

For guaranteed excellent drying results, always use a branded Rinse Aid. No other products are suitable.

Filling the Rinse Aid Dispenser

Refill the dispenser when either the level is at the low level mark by the indicator window, or when the display indicate the rinse aid symbol ().

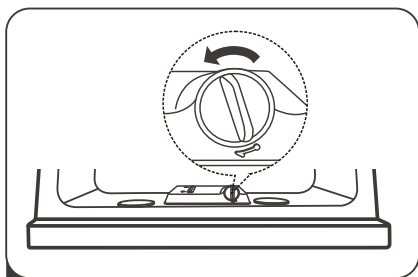

- 1 Undo the plug by turning it anticlockwise.

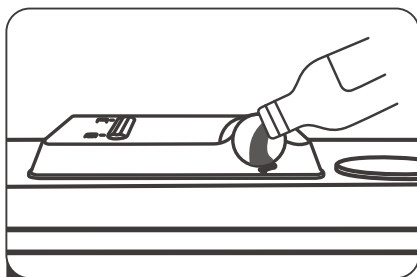

- 2 Fill the dispenser slowly to avoid spillage. Each dispenser will take 300ml from empty.

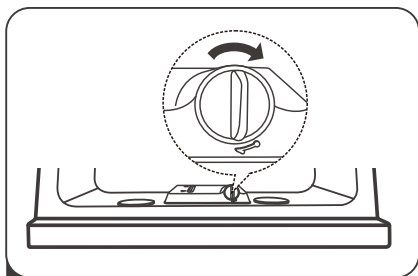

- 3 Close the plug by rotating it clockwise.

 **NOTE:**

It is important to clean up any spills rinse aid, as it will cause excessive foaming in the wash cycle.

Adjusting the rinse aid dispenser

To achieve the best drying result, with the least amount of rinse aid being used, the dispenser can be adjusted by the user.

There are 5 levels of adjustment, the factory setting is D3. This setting will provide excellent drying results.

If the dishes are not drying properly or with cloudy stains, the setting of D4 or D5 will be required.

If there are sticky whitish stains on your dishes or a bluish film on glassware or knife blades, the dispenser can be set back to either D2 or D1 to reduce any unnecessary waste of rinse aid, whilst maintaining excellent drying results.

Follow the steps below:

1. Switch on the dishwasher by press the Power button.
2. Within 60 seconds after step 1, press the Start/Pause button more than 5 seconds, the rinse aid indication blinks.
3. Press the Start/Pause button to select the proper set according to your using habits, the sets will change in the following sequence: D1->D2->D3->D4->D5->D1.
4. Without any operations in 5 second, or exit the set mode through the power button, the new setting is active.

OPERATING THE APPLIANCE

Wash Cycle Table

The table below shows which programs are best for the levels of food residue on them and how much detergent is needed. It also show various information about the programs.

Program	Water temp (°C)	Detergent required grams or tablets	Running Time (min)	Drying Time (min)	Energy usage (Kwh)	Water usage (L)
Auto	Auto wash (45-50°C)					
	Rinse					
	Auto Rinse (50°C)	$\frac{23.75g}{1 \text{ piece}}$	150	40	0.5-1	6-9
	Auto Rinse (60-70°C)					
	Drying					
Intensive	Wash (65°C)					
	Rinse					
	Rinse (45°C)	$\frac{23.75g}{1 \text{ piece}}$	140	35	0.85	11.5
	Rinse (65°C)					
	Drying					
ECO (*AS/NZS 2007.1)	Wash(45°C)					
	Rinse					
	Rinse	$\frac{23.75g}{1 \text{ piece}}$	170	33	0.34	6.7
	Rinse(45°C)					
	Drying					
Heavy	Wash(60°C)					
	Rinse					
	Rinse	$\frac{23.75g}{1 \text{ piece}}$	120	35	0.6	8
	Rinse(60°C)					
	Drying					
Wash&Dry	Wash (55°C)					
	Rinse (55°C)					
	Rinse (55°C)	$\frac{23.75g}{1 \text{ piece}}$	58	17	0.55	11
	Rinse (55°C)					
	Drying					
Super Fast	Wash (50°C)	$\frac{23.75g}{1 \text{ piece}}$	29	0	0.33	4
	Rinse (55°C)					

Program	Water temp (°C)	Detergent required grams or tablets	Running Time (min)	Drying Time (min)	Energy usage (Kwh)	Water usage (L)
Delicate	Wash (50°C)					
	Rinse					
	Rinse	23.75g	85	25	0.45	8.5
	Rinse (55°C)	1 piece				
	Drying					

NOTE:

AS/NZS 2007.1: This program is the test cycle. The information for comparability test in accordance with AS/NZS 2007.1.

Select A Drawer

1. Close the drawer, press the Power button to switch on the machine.
2. Press the Drawer button to choose a drawer. After selecting a drawer, the response light will turn on, and the corresponding drawer program, reservation, and other information are displayed.

NOTE:

After selecting the drawer, all other buttons (except the power button) operate only for the current drawer.

Starting A Cycle Wash

1. After selecting the drawer, press the Program button to select the required program.
2. Press the Start/Pause button, the dishwasher will start its cycle.

NOTE:

- When the current drawer is running, you can press the drawer selection key to switch to another drawer, and set and start the operation. Switch to the running drawer after switching to the non-operating drawer after 5 seconds.
If two drawers are running at the same time,  both drawer indicators light up. This icon "◀" indicates the currently displayed drawer.
- After that the washing cycle of one drawer is ended, meanwhile another cycle in the other basket is still running, the display will continue to show the information above the finished cycle for 5 minutes. After that the information shown will be the one of the currently running cycle.

Changing The Program Once Started

A wash program can only be changed if it has not been running long. You need to ensure that the wash water is still present and it has not drained out and began rinsing. Detergent will have to be re added if there is no wash water present.

Here are the instructions to change the program:

1. Press the Start/Pause button to pause the washing.
2. Press the Program button for more than 3 seconds, the program will be cancelled.
3. Press the Program button to select the desired program.
4. Press the Start/Pause button, the dishwasher will start.

Adding Items While A Wash Is In Progress

You can add items after the wash program has begun.

However if it is no longer in the wash cycle, anything added may not be well washed, and other items soiled as well. Check that it is not rinsing.

Follow these instructions:

1. Press the Start/Pause button to pause the washing.
2. Wait 5 seconds then open the drawer.
3. Add the extra items.
4. Close the drawer.
5. Press the Start/Pause button, the dishwasher will start.

⚠ CAUTION



It is dangerous to open the drawer mid-cycle, as hot steam may scald you.

💡 NOTE:

- When the dishwasher is operating, do not force open the drawer, press the Start/Pause button, and wait a few seconds before opening the drawer.
- If the electric power to the dishwasher is interrupted during a wash program, it will continue to the end of the program when the power is restored.

MAINTENANCE AND CLEANING

Keeping your dishwasher clean improves its performance, reduces unnecessary repairs, and lengthens its life.

WARNING

Disconnect the dishwasher from the power supply (unplug or switch off at the circuit breaker) and allow all its parts to cool before any cleaning or maintenance.

External Care

It's best to clean spills on the outside of your dishwasher as they occur. Use a soft, damp cloth on the control panel to gently wipe away spills and dust. Do not use benzene, wax, thinner, chlorine bleach, or alcohol. These materials may discolor the inner walls and cause stains. Do not clean the dishwasher by sprinkling water over it and avoid letting water come into contact with any of the electrical parts.

NOTE:

If your dishwasher has a stainless steel door panel, you can clean it with a stainless steel cleaner for home appliances or a similar product using a clean, soft cloth.

Internal Care

Filtering system

The filtering system in the base of the wash cabinet traps coarse debris from the washing cycle. The collected coarse debris may cause the filters to clog. Check the condition of the filters regularly and clean them if necessary under running water. Follow the steps below to clean the filters.

CAUTION

- Do not over tighten the filters. Put the filters back in sequence securely, otherwise coarse debris could get into the system and cause a blockage.
- NEVER use the dishwasher without filters in place. Improper replacement of the filter may reduce the performance level of the appliance and damage dishes and utensils.

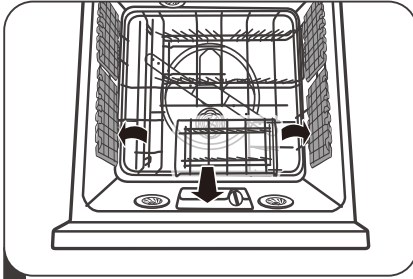

1 Lift up the handles and remove the plate support

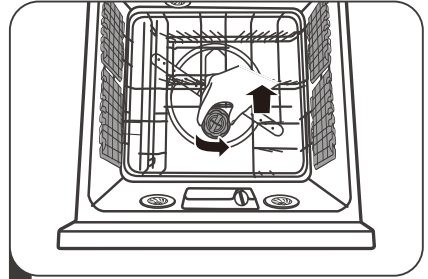

2 Rotate the Cylinder filter counter-clockwise. Lift the Cylinder filter upwards and out of under the basket.

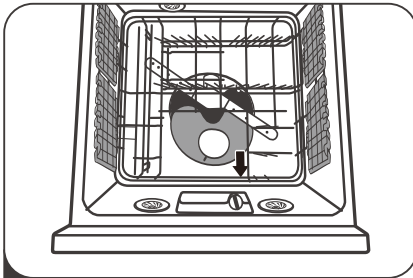

3 Pull forward the Fine filter.

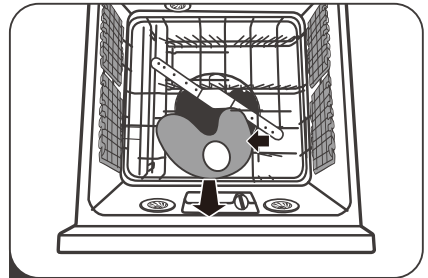

4 Tilt the Fine filter and remove it from under the basket.

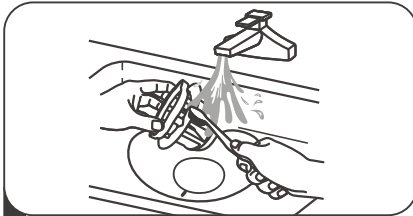

5 Rinse with running water. For a more thorough clean, use a soft cleaning brush.

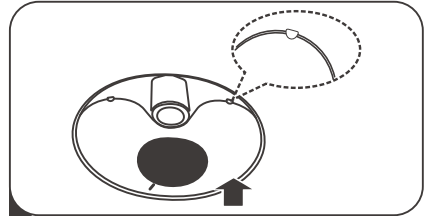

6 Reinstall the filters in reverse order making sure the Fine filter locks into place.

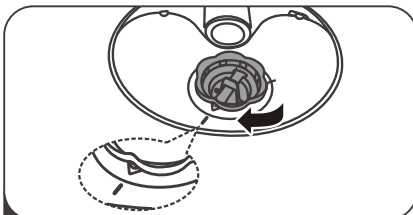

7 Rotate the Cylinder filter clockwise to the close arrow.

Spray arms

If you are in a hard water area, it is necessary to clean the spray arms regularly for hard water chemicals will clog the spray arm jets and bearings.

To clean the spray arms, follow the instructions below:



- 1** One hand raised the basket slightly, and the other hand reached under the basket. Hold the spray arm and lift it up.



- 2** Slightly tilt the arm and remove it from under the basket.

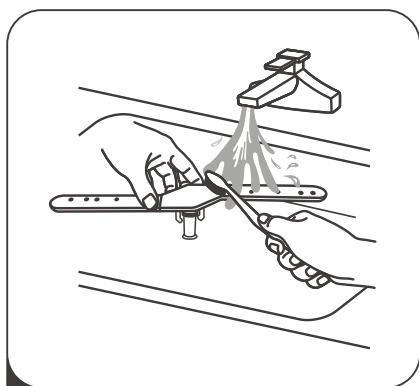

- 3** Wash the arms in soapy and warm water and use a soft brush to clean the jets.
After cleaning, replace it in the opposite direction.

Caring For The Dishwasher

Frost precaution

If you live in a region that is where the inside temperature can drop below zero, care needs to be taken to avoid possible damage if the water in the dishwasher freezes.

1. Turn off the mains power to the dishwasher.
2. Turn off the water supply and disconnect the Water Inlet Hose. Drain the water inside the hose then reconnect.
3. Remove the coarse filters in the tubs and soak up all water possible with a sponge. Then re-assemble.

Cleaning

Only use gentle cleaning products on the exterior of the dishwasher, no solvents or abraasive compounds.

Products specifically for cleaning the stainless steel interior are effective in restoring the original bright interior.

Long term storage

Disconnect the power supply and the water supply.

Remove the coarse filters and soak up all water possible with a sponge.

This reduces the chance of any odors developing inside the tubs.

INSTALLATION INSTRUCTION

Product Dimensions

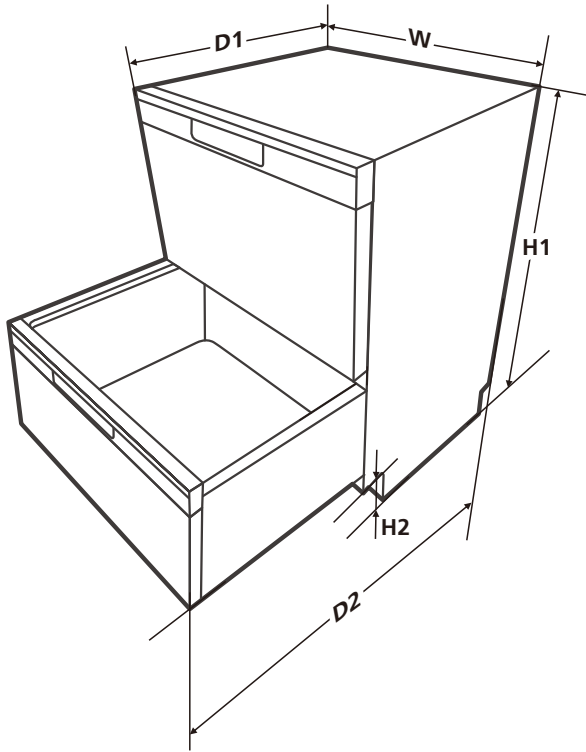

Height (H1)	820 mm
Height (H2)	85-135 mm (Height of kick plate)
Width (W)	595 mm
Depth (D1)	570 mm
Depth (D2)	1080 mm (Drawer open)

Before Installation

Parts supplied

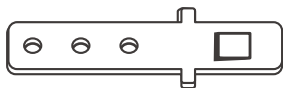

Mounting brackets (4)
(for drain hose coupling)



Ensure that the inner end of the tab is protruding by one material thickness



Wire clamps (2)
(for drain hose coupling)



Hose clamp (1)
(for sink waste connection)

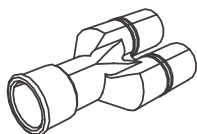

Drain hose coupling (1)



Moisture protection tape (1)



Drain hose support (1)

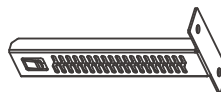

Kick plate brackets (2)
(For installing kick plate)



Screws (8)

Installing Your Dishwasher

Prepare the cavity

The cavity will need to conform to the dimensions in the diagram.

The water supply and power point for the appliance cannot be in the dishwasher cavity. Ideally they should be in an adjacent cavity, easily accessed for isolating the product.

An opening to allow the hoses and power cord to exit is required on either side of the cavity with the minimum dimensions shown.

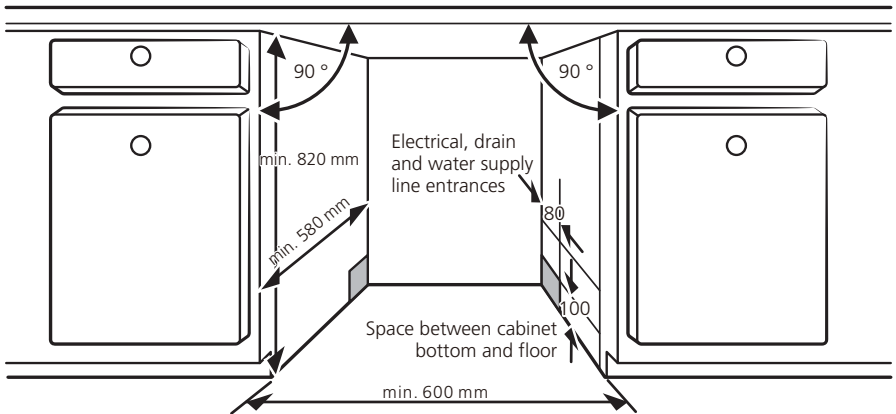

Prepare the dishwasher

Drawer dishwashers are unstable until they are secured to their surrounding cabinetry.

Study the two options for securing offered and choose one that suits your cabinetry.

Fit the mounting brackets supplied to the top or sides of the product, ensuring the locking tab effectively retains the bracket in place. Adjust the tabs if needed.

With the aid of pliers pre form the bracket to match the surface it will be fitted to.

Shorten the tab if needed.

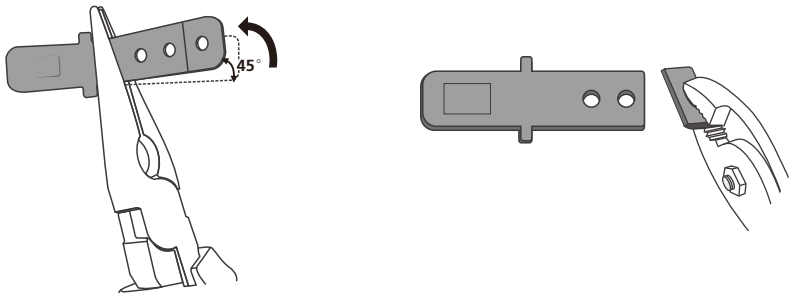

Installation method (A)
Attach top mounting brackets

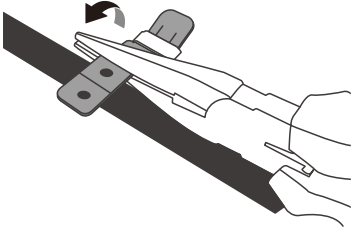
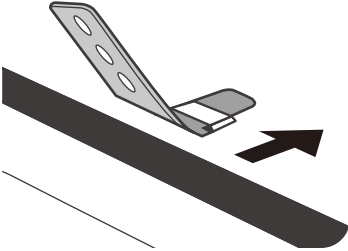
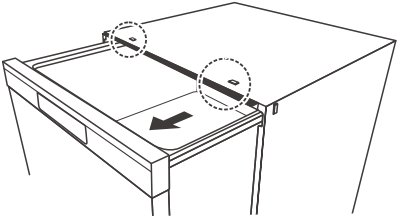

Installation method (B)
Attach side mounting brackets

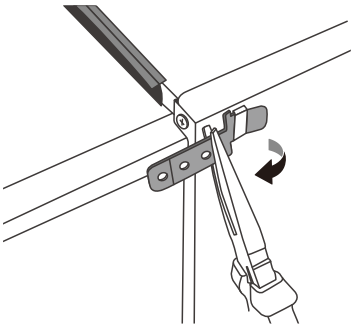
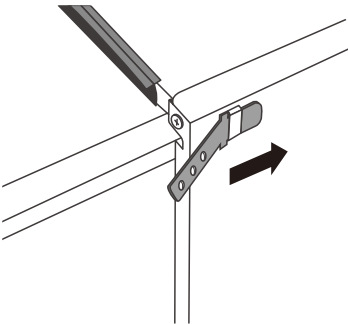
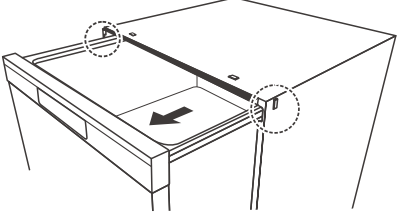

Fit the dishwasher

Position the dishwasher in the cavity so the the drawer fronts are in line with the adjacent cabinetry.

Draw the hoses and power cord through the their opening as you slide the product in. This can be checked by using a spirit level on an open drawer.

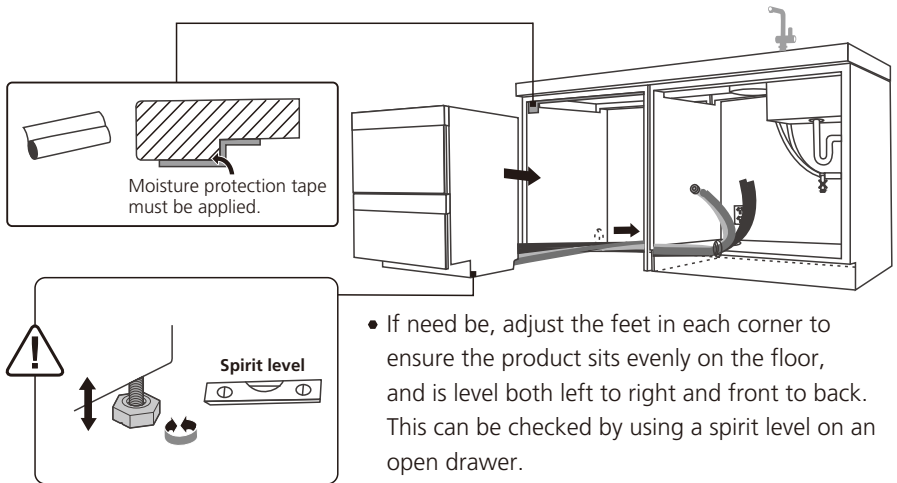

Secure the product in place

With suitable fasteners, fix the mounting brackets to the cabinetry.

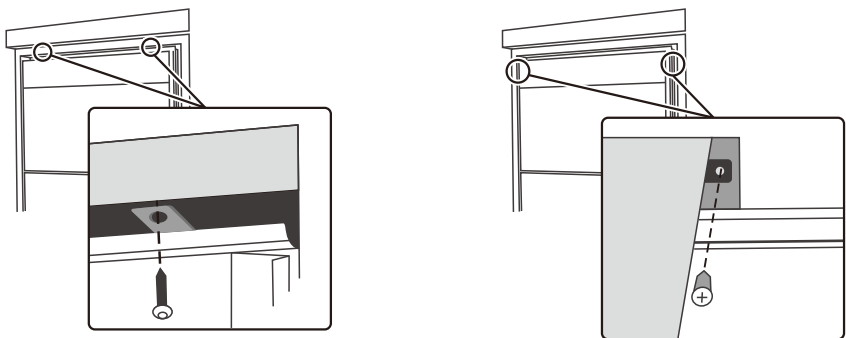

Install the kick plate

1. Prepare a kick plate as shown.

(The mounting hole position is measured by the machine at the factory state. If the height of the feet is adjusted, the position of the mounting hole should be changed according to the actual situation.)

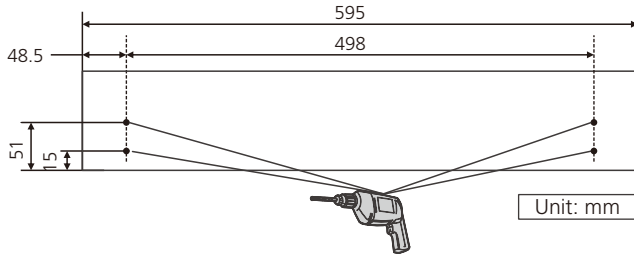

2. Set the insertion length of the kick plate and bend the bracket teeth with pliers.

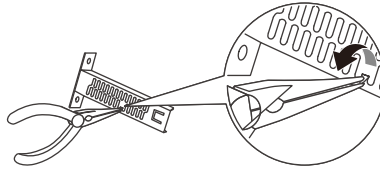

3. Secure the brackets to the kick plate with screws and install the kick plate to the bottom of the dishwasher.

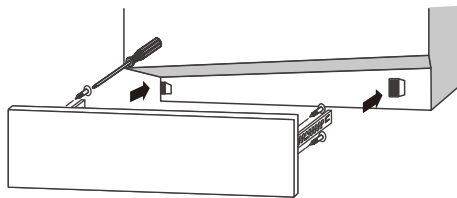

Method A:

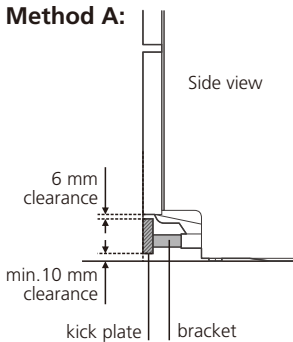

Method B:

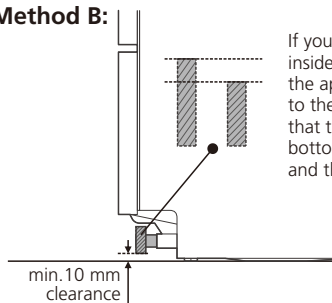

If you need to install the kick plate inside, please cut the kick plate to the appropriate height according to the actual situation, and ensure that the clearance between the bottom surface of the kick plate and the ground is at least 10 mm.

Electrical Requirements

⚠ WARNING



Electrical Shock Hazard

Disconnect electrical power before installing dishwasher.

Failure to do so could result in death or electrical shock.

⚠ Attention

The installation of the pipes and electrical equipments should be done by professionals.

The dishwasher requires a 220 -240 Volt 50 Hz AC supply through a 10 amp rated power outlet.

Ensure that the supply is properly earthed.

Cold Water Connection

Cold water connection

The Inlet Hose supplied requires a 3/4 inch BSP Male fitting, suitable for a flat sealing washer.

A faucet is important for isolating the supply to the dishwasher.

Ensure that the sealing washer supplied inside the hose connection is firmly in place. Check that the initial water is clean, particularly if the supply has not been used for some time.

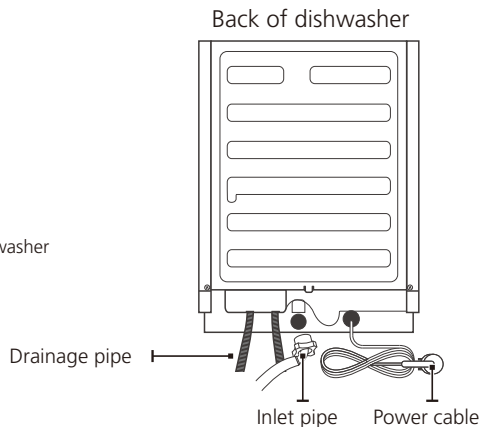
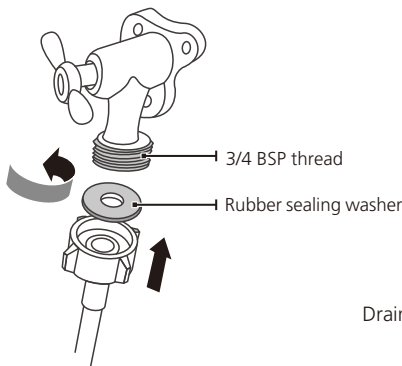

• Connection Of The Drain Hose

There are two recommended options for connecting the drain hose.

Option A: Connecting to the sink waste

This is the typical modern method.

Check if your sink waste pipe has provision for this method.

Beware if it has the drain hose spigot that has never been used, it will likely be blanked off inside the spigot.

This will need careful drilling /cutting out to make it operational. Ensure that the opening you make has no ragged edges that will likely lead to debris snagging over time and causing a blockage.

First cut off the head of the drain hose. When inserting the hoses into the Y piece, wet the hose ends for ease of insertion. Insert fully. Use the hose support clip provided, install as per the illustration. Insure that the hoses have a straight run from the clip to the connection to the waste pipe.

Cut off the head of the drain hose

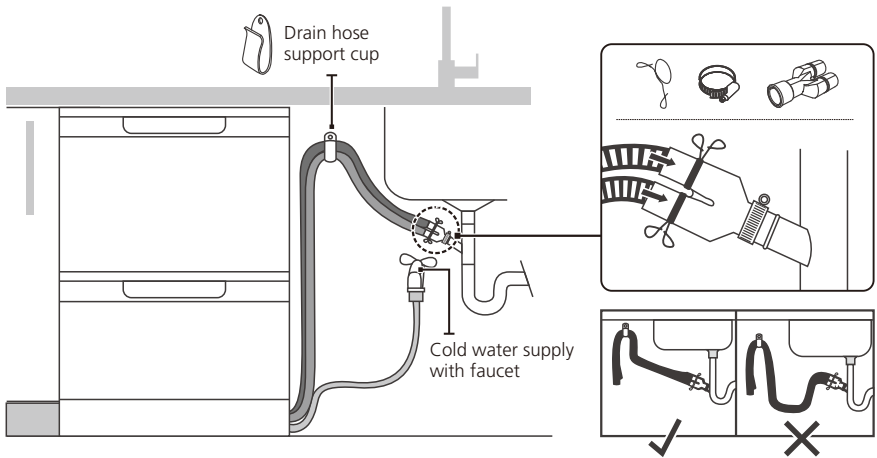

Drain hoses must not loop downwards

Option B: Connecting to a standpipe

The standpipe must be a minimum diameter of 38mm (1 1/2 inch) and requires a trap for odor control.

Use the hose support clip to secure the hoses, ensure they do not enter the standpipe more than 120mm.

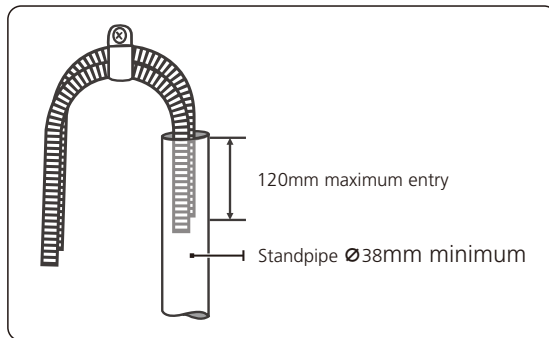
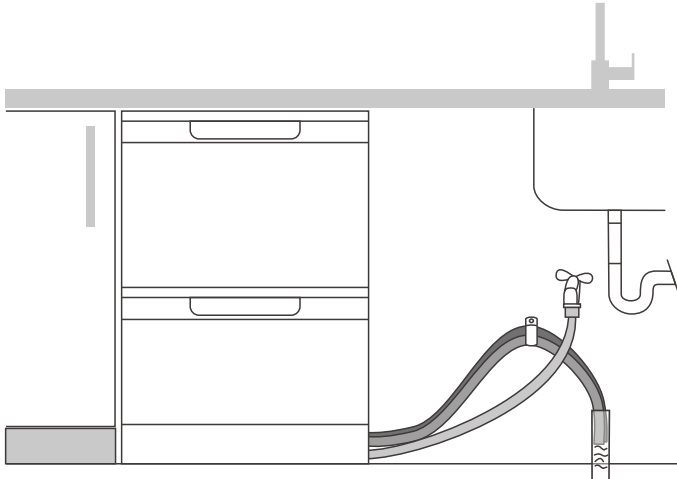

💡 NOTE:

- If there is surplus length of the drain hose it can be shortened. The Inlet Hose cannot be shortened.
- Whilst the very first wash cycle is operating, observe all pipe and hose connections for leaks. Checking for any trace of water on the floor in the cavity where the connections are after the first full cycle is a good practice.

|| TROUBLESHOOTING TIPS

Before Calling For Service

Before calling for service, check the following list for problems probable causes and what you can do.

Problem	Possible Causes	What To Do
Dishwasher won't start	No power.	Check that the power cord is plugged in to a live powerpoint and it is turned on.
	No water supply.	Check that the hose is connected to a water supply and it is turned on.
There is water remaining in the tub	Kinked or blocked drain hose.	Check the drain hose routing.
	Clogged filters in the tub.	Check the filters. If they are clogged, remove them carefully to avoid dropping anything into the sump that could cause a blockage.
The wash items are not clean	Incorrect wash program chosen.	Select a more intensive program
	Obstacle obstructing the spray arm from turning.	Check the washload for items protruding through the bottom of the basket, or if an item has fallen through the basket.
	Loading pattern too tight	Check for adequate spacing between items.
	Filters not correctly in place.	If either filter is found to be out of place, also check spray arm for blockages.
	Blocked spray arm.	Check that the holes in the spray arm are all clear. Back flush with water to clear.
	Insufficient detergent loaded.	Increase detergent quantity



Problem	Possible Causes	What To Do
Wash items are not fully dry	Unloading dishwasher too soon.	The drying cycle must be complete before the dishwasher is unloaded. Check the Display for end time.
	Insufficient Rinse Aid.	Check for Low Rinse Aid Level warning and re fill if necessary.
	Rinse Aid setting too low.	Increase Rinse Aid setting as per instructions on page 20.
Glassware developing cloudy stains and calcium rings	Insufficient Rinse Aid being dispensed.	Adjust the Rinse Aid Dispenser as per the instructions on page 20.
Wash items showing signs of rust	Items are unsuitable for dishwasher use.	Discontinue washing such items in the dishwasher.
Tub becoming dull in color	Tub requires rejuvenation.	Dose the tub with specific Stainless Steel Tub /Bowl Cleaner.
Traces of detergent in the tub	Incomplete/interrupted wash cycle.	Rerun wash program to ensure wash load is not contaminated with detergent.
Foam in the wash tub	Non electric dishwasher detergent used.	Use correct detergent.
	Spilt Rinse Aid present.	Repeat the Rinse Program until clear.

• Error Codes

If there is a malfunction, the dishwasher will display error codes to identify the symptom.

Codes	Meanings	Possible Causes
E1	Extended Water Inlet Time.	Water supply failure, closed faucet, or insufficient supply water pressure.
E3	Water temperature not reaching target.	Heating element malfunction.
E4	Leak Detected.	For some reason water has leaked from the wash system. Possibilities are over height item in the washload stopping lid from sealing; internal plumbing or seal failure.
Ec	Washing Control System failure.	Electronics or Motor failure.
Ed	Failure of connection between Display Unit and the Control System.	Wiring failure between the two devices.
EH	The cover does not open or close properly.	The cover motor device damage or foreign matter stuck.

Product Specification

Manufacturer	MIDEA
Type/Description	WQP12-9501A
Standard place settings	14 (7place/drawer)
Energy efficiency class	 3.5
Water consumption class	 4.5
Standard cleaning cycle	ECO
Energy consumption of the standard cleaning cycle	0.34 kWh
Water consumption of the standard cleaning cycle	6.7 liter
Program duration of the standard cleaning cycle	170 mins
Noise level	47 dB(A) re 1 pW
Mounting	Built-in
Could be built-in	YES
Power consumption	1930-2280 W
Rated voltage/frequency	AC 220-240 V/50 Hz
Water supply pressure	0.04-1.0 MPa=0.4-10 bar



Pronto Service + Support: 1800 440 335
Email: service@eurostylegroup.com.au

HEAD OFFICE

65 Glynburn Road, Glynde SA 5070
Ph: 08 8165 1012

www.euroappliances.com.au